

Data Sheet



Article number: 025848460088

Description: Norma Connect pipe coupling
COMBI GRIP GL W2 Ø88,9/90 NBR 16 bar

Measures

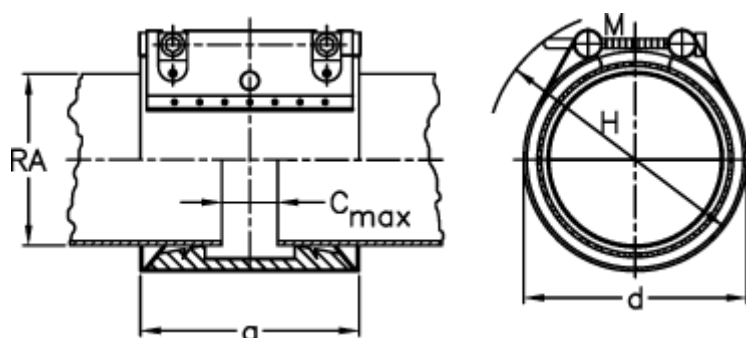

a	= 98.0	RA min-RA max plastic = 89,0-91,0
C max with insertion band	= 25	Weight a piece = 1.6
d	= 110	
H	= 130	
M (screw)	= M10	
Nominal pressure (bar)	= 16	
RA	= 88,9/90,0	
RA min-RA max metal	= 88,0-90,0	